



USE AND CARE GUIDE

Induction Cooktop

Model: EMPV-IDCF9



Distributed by Empava Appliances Inc.
Add: 15253 Don Julian Road, City of Industry, CA, 91745
Tel: (888)682-8882
WWW.EMPAVA.COM



TABLE OF CONTENTS

Important Safety Instructions.....	1-4
Cooktop Features.....	5-10
Using The Cooktop.....	11-15
Operational Cooktop Noises.....	16
Compatible Cookware.....	17
Cleaning Your Cooktop.....	18
Troubleshooting Guide.....	19-20
Installation Instructions.....	21-26

Thank you for purchasing EMPAVA INDUCTION COOKTOP. Please read the entire instruction manual prior to using your unit.

Before installation, record the model and serial number as found on the front of your cooktop. If you require service or call with a question, please have this information ready.

Model: _____

Serial Number: _____

About Induction Cooking

Induction cooking is a safe, advanced, efficient, and economical cooking technology. It works by electromagnetic field generating instant heat directly in the cookware bottom, rather than indirectly through heating the glass surface. The glass becomes hot only because the cookware warms it up.

Our induction cooktop has been tested and complies with Part 18 of the FCC Rules for ISM equipment. Product meets the FCC requirements to minimize interference with other devices in residential installation.

Important Safety Instructions

IMPORTANT Keep these instructions handy for future use.

The appliance is manufactured in compliance with the relevant safety standard.

!WARNING Read all instructions carefully before installation and operation of the appliance.

!WARNING Failure to follow these warnings could result in a fire or explosion that causes property damage, personal injury or death. To reduce the risk of fire, electric shock or injury, take the following precautions:

Intended Use

- This appliance is designed for built-in household use only.
- Do not use outdoors.
- Do not use the appliance to heat a room.

!WARNING **Cooking Safety**



- Do not allow aluminum foil, paper or cloth to come in contact with a hot element.
- Avoid preparing food in aluminum foil or plastic containers over the hot cooking zones.
- Protective liners - Do not use aluminum foil to line cooking zone, drip bowls or oven bottoms, except as suggested in the manual. Improper use of these liners may result in a risk of electric shock or fire.
- Do not allow pans to boil dry or empty.
- Never leave the cooktop unattended when in use.
- Always use the proper pot and pan size.
- The use of undersized cookware will expose a portion of the hot element, which can result in ignition of clothing or personal burners.
- Always remove the covers on sealed or canned goods and before heating to avoid explosion.
- Close supervision is necessary when any appliance is used by or near children.
- Do not touch hot surfaces. Use dry pot holders to hold the handles of pots and pans.
- Use only dry potholders - moist or damp potholders on hot surfaces may result in burns from steam. Do not let the potholder touch hot heating elements.
- Do not use a towel or other bulky cloth.
- Nevertheless, we strongly recommend that a person with physical or mental impairments not use the appliance unless accompanied by a qualified person. The same recommendation applies to children.
- When the unit is on, do not touch outside the control panel as the surface may contain residual heat. It is important to be aware that the unit's surface will remain hot for a short period of time after use. Do not touch hot surfaces.

Important Safety Instructions



WARNING Cleaning Safety

- Do not use steam cleaners or high-pressure cleaners to clean the cooktop, as this may result in electric shock.

Condition of Unit

-  **WARNING** Do not operate any appliance with a damaged cord or after the appliance malfunctions or has been damaged in any manner. Return appliance to the nearest authorized service facility for examination, repair, or adjustment.
-  **IMPORTANT Do Not Cook on Broken Cooktop.** If cooktop break, cleaning solutions and spillovers may penetrate the broken cooktop and create a risk of electric shock.

IMPORTANT Environment of Unit

- To reduce the risk of fire, do not let any objects(glass, paper, etc.) obstruct the inlet and outlet of your cooktop.
- To reduce the risk of electric shock, do not mount unit over a sink.
- To reduce the risk of fire, do not store anything directly on top of the appliance surface when the appliance is in operation.
- Always have a working smoke detector in or near the kitchen.
-  **CAUTION** Do not leave lids or other metal objects such as knives, forks or spoons on the cooktop. If the cooktop is turned on, these objects can heat up quickly and may cause burns. Do not place rough or uneven objects on the units as they may damage the surface. If the cooktop is near a window, ensure that curtains do not blow over or near the unit.
-  **IMPORTANT** Do not use the cooktop as a work surface. Certain substances such as salt, sugar, or sand can scratch the glass ceramic surface. Do not store hard or pointed objects over the cooktop as they can damage the unit if they fall on top.

Important Safety Instructions

Environment of Unit

- Do not put detergents or flammable materials in the equipment installed under the cooktop.
- While cooking any overflowed fat or oil on the cooktop may ignite. There is a risk of burning and fire; therefore, control the cooking process at all times. The use of accessory attachments not recommended by the appliance manufacturer may cause injuries. Items with a magnetic field such as: radios, televisions, credit cards, cassette tapes etc., can affect the unit. The marked electrical rating should be at least as great as the electrical rating on the appliance.
- To prevent accidents and achieve optimal ventilation, allow for sufficient space around the cooking area.
-
- **⚠ CAUTION** Do not store items of interest to children in cabinets above the range or on the backguard of a range - children climbing on the range to reach items could get seriously injured.
Use proper cookware size - This appliance is equipped with four Cooking Elements of different sizes. Choose cookware with a flat bottom large enough to cover the unit heating surface. The use of undersized cookware will expose a portion of the heating surface where direct contact may be made and cause serious injury. Compatible cookware will improve efficiency.

- To reduce risk of burns, ignition of flammable materials, and spillage due to unintentional contact with cookware, the cookware handles should be turned inward and not extend over adjacent heating surface.
- Wear proper apparel - loose fitting or hanging garments should never be worn while using the appliance.

⚠ WARNING Power Cord Safety

- **⚠ WARNING** To protect against electric shock, do not immerse cord, or main body in water or any other liquid.
- Do not let cord hang over edge of table or counter.
- Do not allow cord to touch hot surface. A short power supply cord or detachable power supply cord should be used to reduce the risk of becoming entangled in or tripping over a longer cord.
- Always attach plug to appliance first, then plug cord into the wall outlet. To disconnect, turn any control to off, then remove plug from wall outlet.
- The cord should be arranged so that it will not drape over the countertop where it can be pulled on by children or tripped over.

Important Safety Instructions

Service and Repair Safety

- **⚠️ WARNING** Do not repair or replace any part of the appliance unless specifically recommended in the manual. All other services should be referred to a qualified technician.

This product may not be treated as household waste. Instead it should be handed over to the applicable collection point for the recycling of electrical and electronic equipment. By ensuring this product is disposed of correctly, you will help prevent potential negative consequences for the environment and human health, which could otherwise be caused by inappropriate waste handling of this product. For more detailed information about recycling of this product, please contact your local city office, your household waste disposal service or the shop where you purchased the product.

SAVE THESE INSTRUCTIONS

Cooktop Features

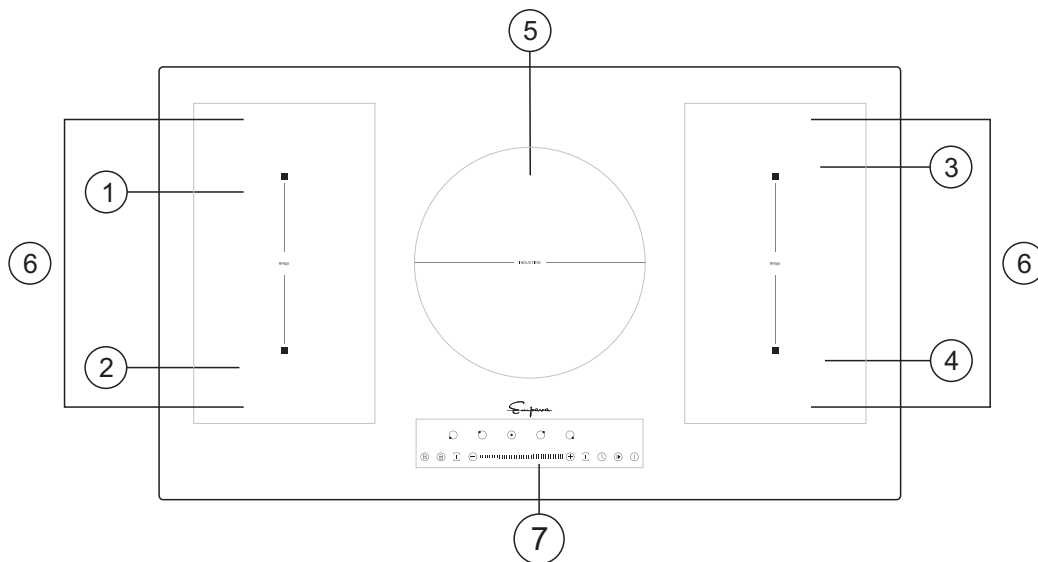

- 1. 1600W boost to 2000W
- 2. 2000W boost to 2500W
- 3. 2000W boost to 2500W

- 4. 1600W boost to 2000W
- 5. 2400W boost to 3700W
- 6. Flex zone, 2500W boost to 3000W
- 7. Control panel

Control Panel

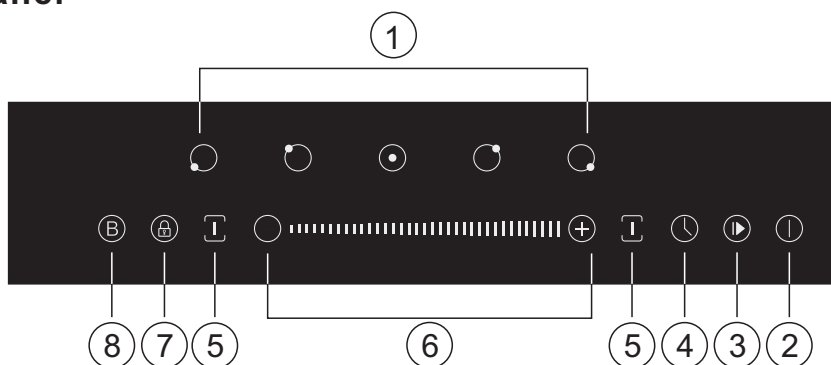

- 1. Heating zone selection controls
- 2. Main Power On/Off
- 3. Sotp/Go
- 4. Minute Timer
- 5. Flex zone key
- 6. Power regulating slider control
- 7. Controls Lock
- 8. Power Boost

Cooktop Features

Specifications

Model	EMPV-IDCF9
Product dimension(wxdxh) inch	36" x 21" x 2 1/8"
Cut-out dimension(wxd) inch	Min.:35 7/32" x 19 7/8" Max.:35 7/16" x 20 1/16"
Voltage (volts)	240
Frequency (Hz)	60
Total power (Watts)	9300
Minimum circuit breaker Amperage	50
Elements	5
Front Left	2000W/2500W
Rear Left	1600W/2000W
Front Right	1600W/2000W
Rear Right	2000W/2500W
Center	2400W/3700W

Heat Setting Displays

DISPLAY	DESCRIPTION
-	No power level for the element
1-9	The power level
P	The power boost
H	A cooking element is still hot to touch (residual heat)
E	Electronics fault error message of specific cooking element
E0-E9	Error code
0	STOP/GO

To start cooking

After power on, the buzzer beeps once, all the indicators light up for 1 second then go out, indicating that the induction cooktop has entered the state of standby mode.

- Touch the ON/OFF  control, the buzzer beeps once indicating that the induction cooktop has entered the state of standby mode, the Power indicator light up.



- Place a suitable pan on the cooking zone that you wish to use. Make sure the bottom of the pan and the surface

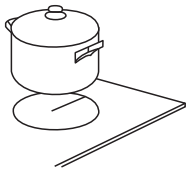

- Touching the heating zone selection control, and a indicator next to the key will flash



- Select a heat setting by touching the “-” or “+” control or sliding the setting selector with your finger.

If you don't choose a heat setting within 30 seconds, the induction hob will automatically switch off. You will need to start again at step 1.

You can modify the heat setting at any time during cooking.

By holding down either of these buttons, the value will adjust up or down.

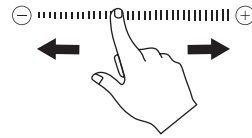

Using the Boost

Boost is the function that one zone rising to a larger power in one second and lasting for 10 minutes. Thus you can get a more powerful and faster cooking.

When you have finished cooking

- Touching the heating zone selection control that you wish to switch off.

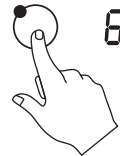

- Turn the cooking zone off by touching the “-” or sliding the setting selector and scrolling down to “0”.

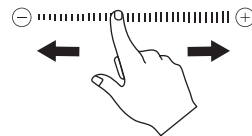

- Turn the whole cooktop off by touching the “ON/OFF” control.



Using The Cooktop

- Beware of hot surfaces
“H” will show which cooking zone is hot to touch. It will disappear when the surface has cooled down to a safe temperature. It can also be used as an energy saving function if you want to heat further pans, use the hotplate that is still hot.



Using the Boost to get larger power

- Touch the heating zone selection button that you wish to boost, an indicator next to the key will flash.



- Touch the Boost button, the heating zone will begin to work at Boost mode. The power display will show “P” to indicate that the zone is boosting.

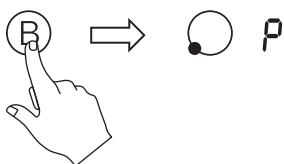

After we set Boost function. The Boost power will last for 10 minutes. After 10 minutes, the zone will switch back to the power stage 9

If you want to cancel the Boost during this 10 minutes, touch the heating zone selection button, an indicator next to the key will flash. And Either touch or slide the setting selector to a new setting or to 0 to turn the cooking zone off.

Power restrictions when using boost function

- The five zones were divided into two groups. If use boost on left group, please use another boost in right group.

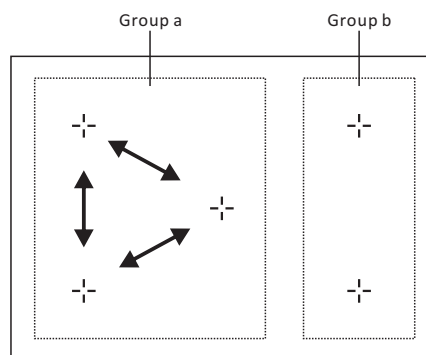

Power management function

- Cooking zones are divided into two groups. Left group has a maximum electricity loading of 4800W, right group has a maximum electricity loading of 4500W. The power level displayed may be different from the actual power level at the power sharing and high temperature cooking. To prevent the hob from overheating, the power level is controlled automatically.

Flex Zone

- This area can be used as a single zone or as two different zones, accordingly to the cooking needs anytime.
- Flexible area is made of two independent inductors that can be controlled separately. When working as a single zone, a cookware is moved from one zone to the other one within the flexible area keeping the same power level of the zone where the cookware originally was placed, and the part that is not covered by cookware will not heat.

Using The Cooktop

- Important: Make sure to place the cookwares centered on the single cooking zone. In case of big pot, oval, rectangular and elongated pans make sure to place the pans centered on the cooking zone covering both cross.

Examples for good and bad pot placements:

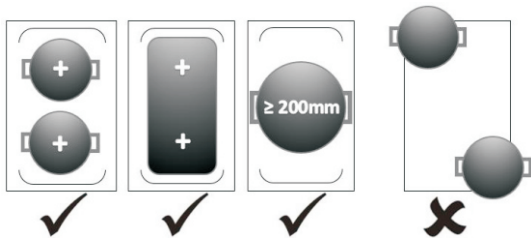

As big zone

- To activate the free area as a single big zone, simply press the Flex zone key.

The light above Flex zone key will light, which indicate Flex zone has been activated.



- Adjust heat setting by touching the slider control.

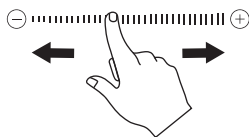

As two independent zones

To use the flexible area as two different zones with different power settings, touching the “-” or sliding the setting selector and scrolling down to “0” the flexible area will turn to two independent heating zones.

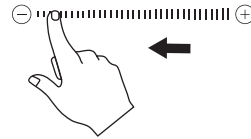

Controls Lock

- You can lock the controls to prevent unintended use (for example children accidentally turning the cooking zones on).
- When the controls are locked, all the controls except the ON/OFF control are disabled.



To lock the controls

Touch and hold the keylock control  for 3 seconds. The lock indicator will light up.

To unlock the controls

- Make sure the induction hob is turned on.
- Touch and hold the keylock control  for 3 seconds.
- You can now start using your induction hob.



When the hob is in the lock mode, all the controls are disabled except the ON/OFF  you can always turn the induction hob off with the ON/OFF  control in an emergency, but you shall unlock the hob first in the next operation.

Over-Temperature Protection

A temperature sensor equipped can monitor the temperature inside the induction hob. When an excessive temperature is monitored, the induction hob will stop operation automatically.

Residual Heat Warning

When the hob has been operating for some time, there will be some residual heat. The letter “H” appears to warn you to keep away from it.

Auto Shutdown

Another safety feature of the hob is auto shut down. This occurs whenever you forget to switch off a cooking zone. The default shutdown times are 2 hours.

Using the Timer

- You can set it to turn one or more cooking zone off, each cooking zone has individual timer setting.
- You can set the timer for up to 99 minutes.

Setting the timer to turn one cooking zone off

- Touch timer control until time light of the desired cooking zone is ON, The minute timer minder and cooking zone element symbol indicator will start flashing and “00” will show in the timer display.



- Set the time by touching the “-” or “+” control or sliding the setting selector of the timer

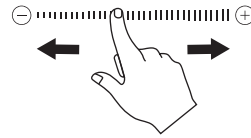

Hint: Touch the “-” or “+” control of the timer once will decrease or increase by 1 minute.

Touch and hold the “-” or “+” control of the timer will decrease or increase by 10 minutes.

- Touching the Timer key until time light of the desired cooking zone is ON, touching the “-” or sliding the setting selector and scrolling down to “00”, the timer is cancelled.

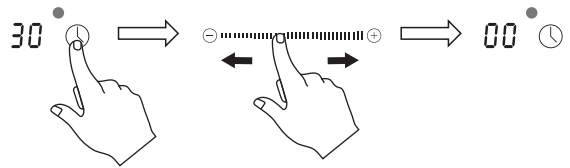

- When the time is set, it will begin to countdown immediately. The display will show the Remaining time and the timer indicator flash for 5 seconds.

- When cooking timer expires, the corresponding cooking zone will be automatically switch off.

Setting the timer to turn more than one cooking zone off

- If more than one heating zone use this function, the timer indicator will show (e.g. zone 1# setting time of 3 minutes, zone 2# setting time of 6 minutes, the timer indicator shows “3”).

If you want to check the set time of other heating zone, touch the Timer key until time light of the desired cooking zone is ON. The timer will indicate its set time.



- When cooking timer expires, the corresponding Time cooking zone symbol will be switch off Automatically.

NOTE: If you want to change the time after the timer is set, you have to start from step 1

Residual Heat Indicator



After using any of the Cooking Element, the cooking area will remain hot. Even after turning off the entire unit, the surface of the cooktop will remain hot for some time. The digital display for the Cooking Element will show an “H” to warn the user that the surface is hot to touch(Hot surface indicator) after the Cooking Element switch off. Wait until the “H” is no longer displayed to

clean the unit. You may turn the Cooking Element back on even if the “H” is displayed.

Stop/Go

Use the Stop/Go function to 'Pause' the cooktop for Max. 10 minutes while cooking; the unit will be automatically switched off if Stop/Go is not touched again within 10 minutes.

To turn on

One or more cooking zones are active. Touch Stop/Go key pad, a “beep” will sound, the indicator light above the Stop/Go will be lit up and all opened Power digital display of the cooktop will show blinking like marching ants.

Any set cooking timers/minute stop, When deactivating "Stop and Go", the countdown will continue.

All of the buttons are inactive except for Stop/Go, Lock and ON/OFF and POWER key.

If no any key are touched within 10 minutes, all of the active cooking zones are automatically switched off.

To turn off

Touch Stop/Go key again within 10 minutes, the indicator light above Stop/Go button will go off, and the cooktop continues with the settings that were set before the Stop / Go.

Operational Cooktop Noises

Cookware Noise

The induction fields are generated by electronics equipment, which are pretty much silent but they do produce heat at high power level. A soft-sounding cooling fan run when the unit is running multiple cooking elements at high settings at once or when a cooking element is set at very high power settings.

What can sometimes produce sound with induction cooking is not the induction equipment but the cookware itself. Slight sounds may be produced by different types of cookware. Some of the possible causes include:

- Heavier pans such as enameled cast iron produce less noise than a lighter weight multi-ply stainless steel pan; Light weight cookware may also vibrate. Heavy weight quality cookware is recommended.
- Cookware with irregular or warped bottoms can vibrate audibly on the ceramic glass surface, though again typically only at high power settings.
- A “Cracking” noise may be heard if the cookware base is made of layer of different material.
- A low “humming” noise occurs when cooking, which is normal particularly at high power settings.
- Whistling can occur if both elements are being used at the same time at the high settings, and the cookware has bases made of layer of different material.
- Loose-fitting handles on cookware, typically when riveted on, can vibrate slightly.
- High quality cookware of solid cast iron including enamelware will lower the noise.

Compatible Cookware

The quality of your cooking is dependent on the cookware you use. Because induction cooking requires a magnetic vessel for heating, only certain materials can be used on your cooktop.

Induction requires pots and pans that are made of ferrous (meaning magnetic) materials.

Check your cookware's retail box for the induction symbol. To tell if your current cookware is compatible with the induction technology, grab a magnet and see if it holds to the bottom of the cookware. If your magnet stays on then your cookware is ready to be used on the Induction cooktop!

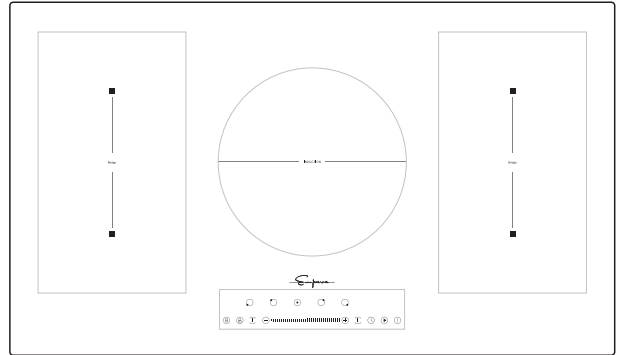

Optimally the cookware will have this induction image on the retail box:

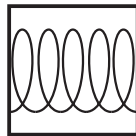

Induction

The following are **not** compatible: heat-resist glass, ceramic, copper, aluminum pan/pots, round-bottomed cookware, or cookware with a base less than 5 inches.

NOTE: Some cookwares can produce noises when used on induction cooking zones. This is not a fault in the cooktop, and its function will not be impaired in any way as a result.

Cleaning Your Cooktop

Please follow these directions along with Important Safety steps for cleaning, advised at the beginning of the manual. Use a ceramic glass cleaner on the glass cooktop. To maintain and protect the surface of your glass cooktop, follow these steps:

Before using the cooktop for the first time, clean it to protect the top and makes cleanup easier.

1. Daily use of ceramic glass cleaner when the cooktop is cool will keep the cooktop looking new.
2. Shake the cleaning solution well. Apply a few drops of ceramic glass cleaner directly to the cooktop.
3. Use a paper towel or a soft cleaning pad for ceramic surface to clean the entire cooktop surface.
4. Use a dry cloth or paper towel to remove all cleaning residue. No need to rinse. Never run the cooktop under water.

Cleaning Burned on Residue:

NOTE: It is very important that you **DO NOT** use the cooktop until it has been thoroughly cleaned.

WARNING: Damage to the glass surface may occur if you use scrub pads or any other type of abrasive cleaning materials.

1. Allow the cooktop to cool.
2. Spread a few drops of the ceramic glass cleaner on the burned residue area.
3. Using the ceramic glass cleaning pad, rub the residue area, applying pressure as needed.
4. If any residue remains, repeat the steps listed above.
5. For additional protection, after all residue has been removed, polish the entire surface with the ceramic glass cleaner and a paper towel.

Cleaning heavy burned - on residue:

1. Allow the cooktop to cool.
2. Used a singleedge razor blade scraper approximately at a 45 degree angle against the glass surface, and scrape offtheresidue.
3. After scraping off the residue, apply a few drops of the ceramic glass cleaner on the entire burned residue area. Use the cleaning pad to remove any remaining residue.
4. For additional protection, after all residue has been removed, polish the entire surface with the ceramic glass cleaner and a paper towel.

Metal Marks and Scratches:

Be careful not to slide pots or pans across the cooktop surface. It will leave behind metal markings. These marks are removable using the ceramic glass cleaner along with the cleaning pad for induction cooktop.

If pots with a thin overlay of aluminum or copper boil dry, the overlay may leave a black discoloration on the cooktop. This should be removed immediately before using the cooktop again or the discoloration will become permanent.

NOTE:If cracks or indentations in the glass surface occurs, the cooktop glass will have to be replaced. Contact the manufacturer for assistance.

Troubleshooting Guide

If you encounter the following problems while using your cooktop, check the guide below to see if you can correct the problem yourself before calling for assistance or service:

Problem	Possible Cause	Solutions
<ul style="list-style-type: none"> • Cooktop does not work 	<ul style="list-style-type: none"> • Cooktop controls are locked • Power outage • Installation wire not complete • Circuit breaker has tripped or fuse is blown 	<ul style="list-style-type: none"> • Make sure Lock mode is turned off • Check house lights to confirm power outage
<ul style="list-style-type: none"> • Cooktop does not heat 	<ul style="list-style-type: none"> • No cookware or improper cookware placement on the cooking element • Incorrect cookware size for the selected cooking element • Cookware is not properly resting on cooking element • Incorrect cooking element selected • No power to cooktop 	<ul style="list-style-type: none"> • Make sure that the cookware is centered on the cooking element, and that cookware is also of correct type for induction cooking. See Compatible Cookware • The bottom of the cookware must be large enough to cover cooking element completely. See Compatible Cookware • Cookware bottoms must be flat and centered on the cooking element. See Compatible Cookware • Make sure the correct control is ON for the cooking element being used • See “Cooktop does not work” above
<ul style="list-style-type: none"> • Cooktop turns off while cooking 	<ul style="list-style-type: none"> • Cooktop internal heat sensor has detected high temperature inside the cooktop, activating automatic shut off • Liquid or object on the controls area 	<ul style="list-style-type: none"> • Make sure the cooktop vents are not blocked • The cooktop features an automatic shutoff feature that turns off the entire cooktop if any cooking element has been on continuously for 2 hours • The cooktop control panel may register liquids or objects obstructing the panel, which can cause the cooktop to shut off. Clean up spills or remove objects and restart the unit

Troubleshooting Guide

If you encounter the following problems while using your cooktop, check the guide below to see if you can correct the problem yourself before calling for assistance or service:

Problem	Possible Cause	Solutions
<ul style="list-style-type: none"> • Power boost does not work 	<ul style="list-style-type: none"> • Boost function is not available if adjacent burner of the left group is in use and total power reach 4800W 	<ul style="list-style-type: none"> • See Power Sharing
<ul style="list-style-type: none"> • The fans keep running for one minute after the cooking element has been switched off 	<ul style="list-style-type: none"> • The electronics are cooling down 	<ul style="list-style-type: none"> • This is a normal occurrence
<ul style="list-style-type: none"> • “E” appears in the Power display 	<ul style="list-style-type: none"> • Electronics fault error message of particular cooking element 	<ul style="list-style-type: none"> • See E0, E1, E2, E3, E7, E8, E9, EE
<ul style="list-style-type: none"> • “E0” appears in the Timer display 	<ul style="list-style-type: none"> • IGBT overheating 	<ul style="list-style-type: none"> • Turn off unit to allow IGBT to cool. Restart unit
<ul style="list-style-type: none"> • “E1” appears in the Timer display 	<ul style="list-style-type: none"> • No cookware found or improper placement of cookware on the cooking element 	<ul style="list-style-type: none"> • Make sure that the cookware is centered on the cooking element, and that it is also induction compatible. See Compatible Cookware
<ul style="list-style-type: none"> • “E2” appears in the Timer display 	<ul style="list-style-type: none"> • Supplied voltage to cooktop is too low 	<ul style="list-style-type: none"> • This may be caused by reduced voltage being supplied to the house circuit. If connections are correct and the supplied voltage returns to normal, the code will disappear
<ul style="list-style-type: none"> • “E3” appears in the Timer display 	<ul style="list-style-type: none"> • Supplied voltage to cooktop is too high 	<ul style="list-style-type: none"> • This may be caused by increased voltage being supplied to the house circuit. If the connections are correct and the supplied voltage returns to normal, the code will disappear
<ul style="list-style-type: none"> • “E7” appears in the Timer display 	<ul style="list-style-type: none"> • NTC1 Break off 	<ul style="list-style-type: none"> • Turn the cooktop OFF; then pull plug out for about 30 seconds. Then re-insert the plug and turn the cooktop on using the POWER pad. If the error message is still displayed, call for service
<ul style="list-style-type: none"> • “E8” appears in the Timer display 	<ul style="list-style-type: none"> • NTC1 Short circuit 	
<ul style="list-style-type: none"> • “E9” appears in the Timer display 	<ul style="list-style-type: none"> • NTC2 Break off 	
<ul style="list-style-type: none"> • “EE” appears in the Timer display 	<ul style="list-style-type: none"> • NTC2 Short circuit 	
<ul style="list-style-type: none"> • Noise 	<ul style="list-style-type: none"> • Noise like humming, crackling and buzzing 	<ul style="list-style-type: none"> • This is a normal occurrence, See Operational Cooktop Noises

IMPORTANT SAFETY INFORMATION

⚠ WARNING Installation and service must be performed by a qualified installer or service technician.

IMPORTANT Read and save these instructions for future reference.

⚠ DANGER Always read and obey all safety information, failure to follow these instructions can be killed or seriously injured.

Before Installing the cooktop

1. Visually inspect the cooktop for damage. Also make sure all cooktop screws are on tight.
 2. Record the model and serial number as found on the bottom of your cooktop. When ordering parts for or making inquires about your cooktop, always be sure to include the model and serial numbers and a lot number or letter from the serial plate on your cooktop.
 3. Cutout dimensions of the countertop.
 4. Make sure the wall coverings, countertop and cabinets around the cooktop can withstand heat (up to 200°F) generated by the cooktop.
 5. Gently lower the cooktop into the countertop cutout.
- NOTE:** Do not seal the cooktop to the countertop, the cooktop must be removable if service is necessary.

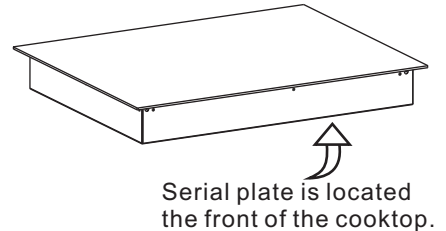

Electrical Connection

⚠ IMPORTANT Observe all governing codes and local ordinances.

Model EMPV-IDCF9 needs 50 Amp service.

Maximum Connected Load

Model EMPV-IDC9F9.3 kW at 240VAC, 8.3 kW at 208VAC

Installation Instructions

The Induction Cooktops must connect to a separate, grounded wire, single phase, AC Only electrical supply with their own circuit breaker. These appliances must be installed in accordance with National Electrical Codes, as well as all state, municipal and local codes. This appliance must be supplied with the proper voltage and frequency and amperage, which is protected by a properly sized circuit breaker or time delay fuse.

The cable from appliance is equipped with 3-wires:

If 3-Wire Cable from Home Power Supply

IMPORTANT: Use the 3-wire cable from Home Power Supply where local codes permit a 3-wire connection.

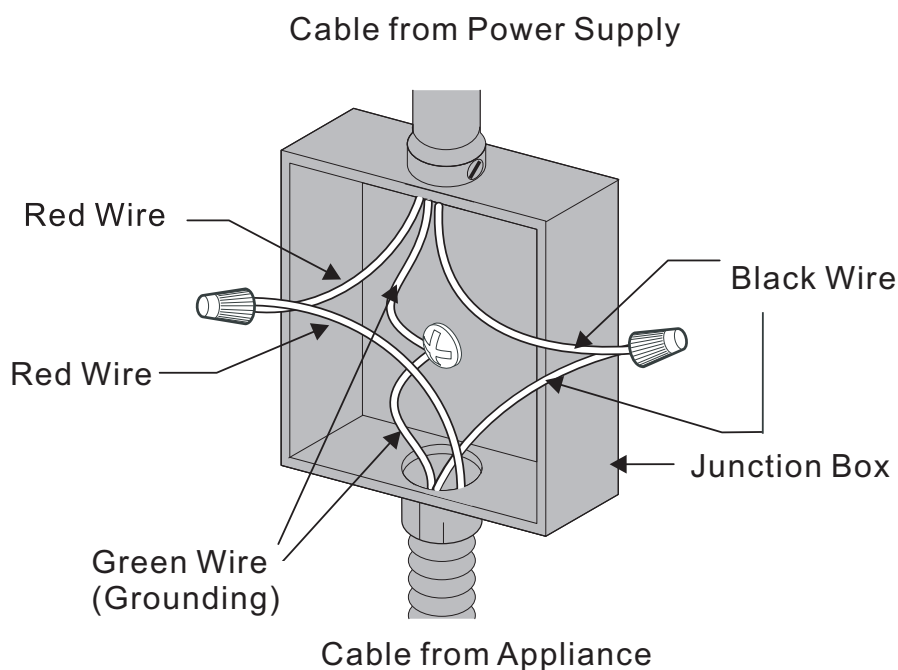

3-Wire Cable from Home Power Supply

If 4-Wire Cable from Home Power Supply

IMPORTANT: Use the 4-wire cable from Home Power Supply where local codes do not allow grounding through neutral.

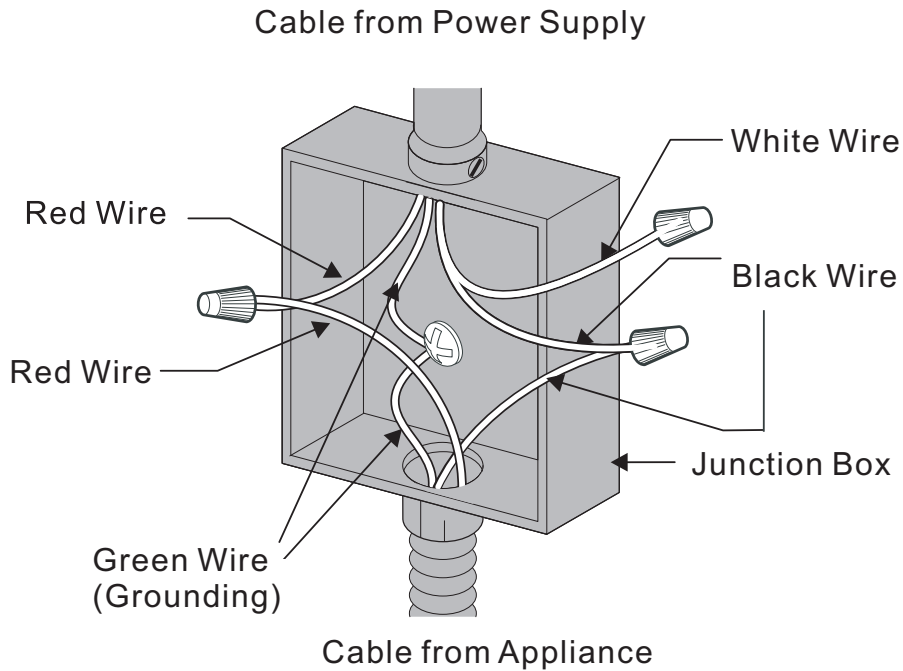

4-Wire Cable from Home Power Supply

Electrical ground is required on this appliance

⚠ WARNING The cooktop conduit wiring is approved for copper wire connection only, if you have aluminum house wiring, use only special connectors which are approved for joining copper and aluminum wires conform with local codes and ordinances. Follow the electrical connector manufacturer's recommended procedure closely.

Installation Instructions

Installation — 36" (91.4cm) Model EMPV-IDCF9

Cooktop Dimensions		
A. Width	B. Depth	C. Height
36"(914)	21"(533)	2 1/8"(55)

* DO NOT obstruct these areas.

IMPORTANT: For perfect ventilation, provide a vent of under the countertop, in the front of the cabinet and in the back of the cabinet. The ventilation opening is to extend the full length of the cooktop cutout.

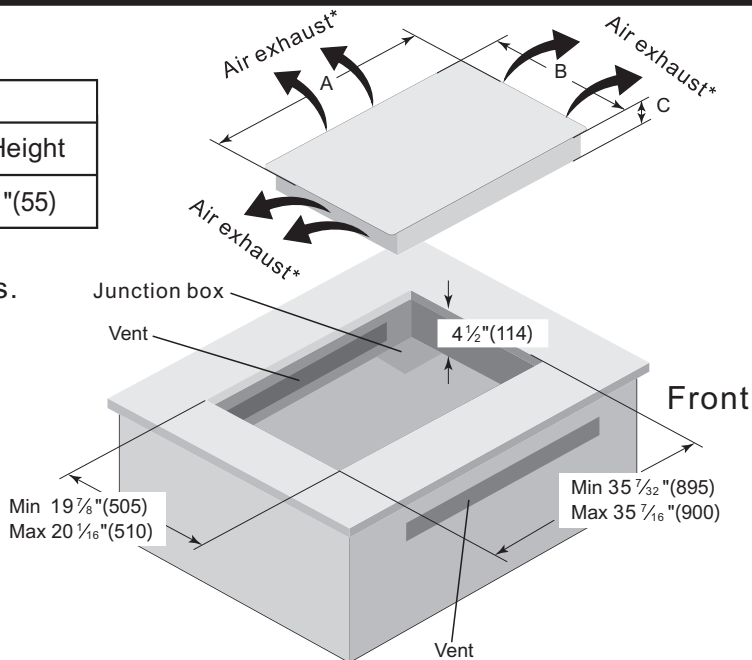

EMPV-IDCF9 Cooktop and Cutout Dimension

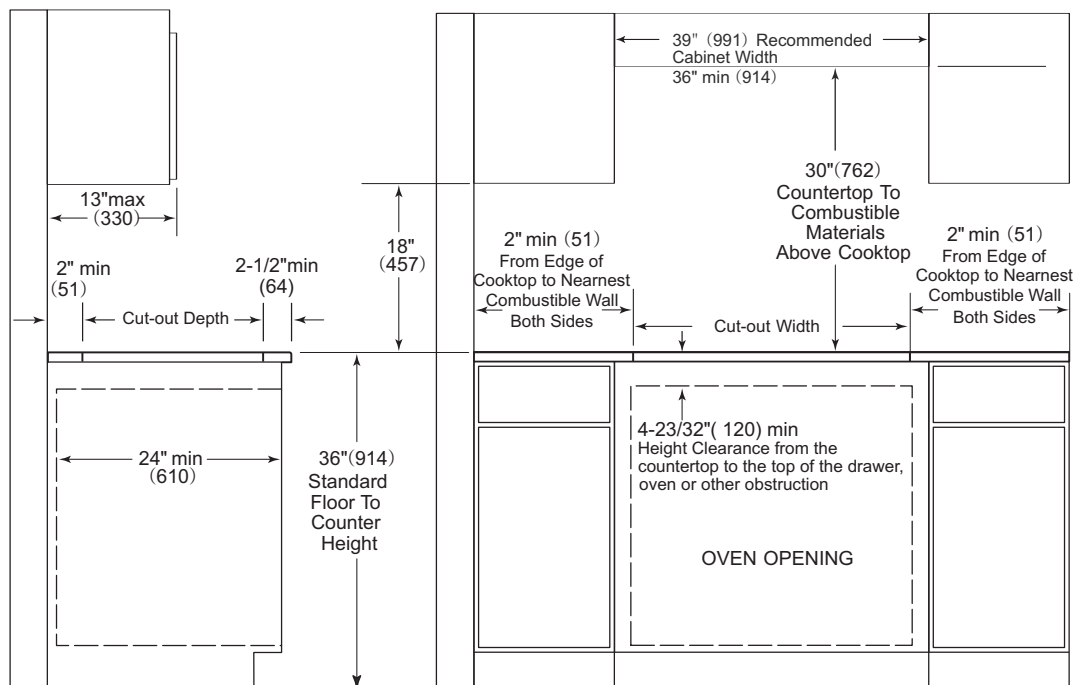

EMPV-IDCF9 Countertop Cut-Out Opening

All dimensions are stated in inches and (mm).

Installation Instructions

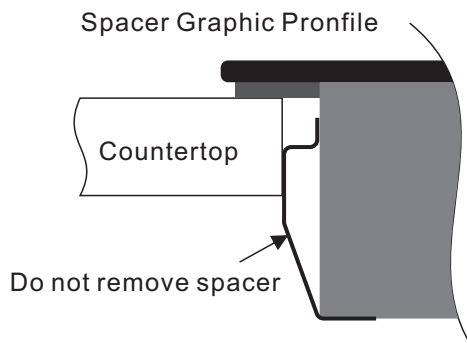
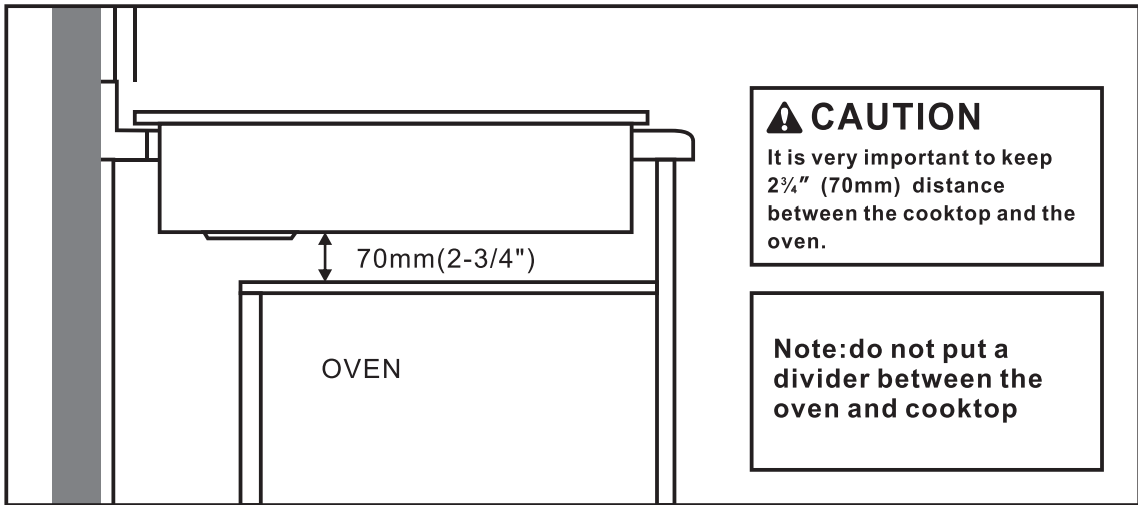

NOTE: The cooktops include spacers on both sides to ensure proper airflow once installed. Do not remove the spacers.

Installation Instructions

After Installation

1. Remove all the stickers and items from the top of the cooktop surface.
2. Clean cooktop before use. Dry with a soft cloth. See **Cleaning Your Cooktop** for reference.
3. Read **Using The Cooktop**.
4. Turn on the power to the cooktop.
5. Verify all function operation properly.

NOTE: If the cooktop does not work, or you met any problem in your operation, please check that the circuit breaker has not tripped or the house has not blown. For more information, please See **Troubleshooting Guide**. If you do not solve the problem by yourself, please call us for assistance or service.